

华为云 技术 私享会



华为云
技术
私享会

华为云新一代分布式缓存Redis (DCS2.0)



一个关于缓存的User case



在中等负载（5万 request/s）下，用户-应用 端到端时延：300ms~500ms



在中等负载（5万 request/s）下，用户-应用 端到端时延：70ms~90ms

一组关于缓存的测试数据

Normal Backend (transactions per second)

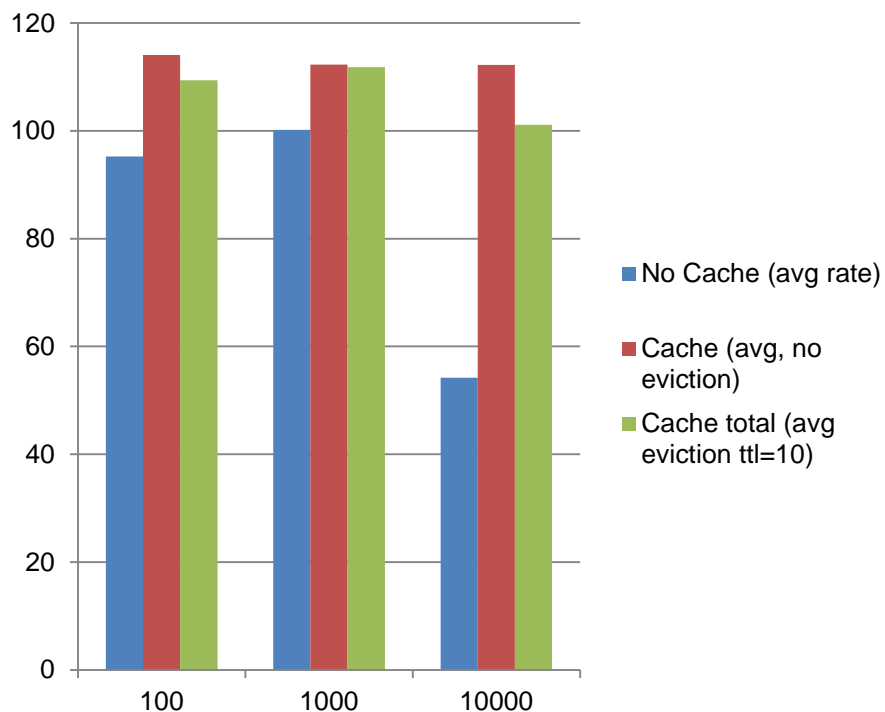

Performance is based on measurements and projections using standard benchmarks in a controlled environment. Actual performance in a user's environment may vary.

Polling database with a five second network latency (transactions per second)

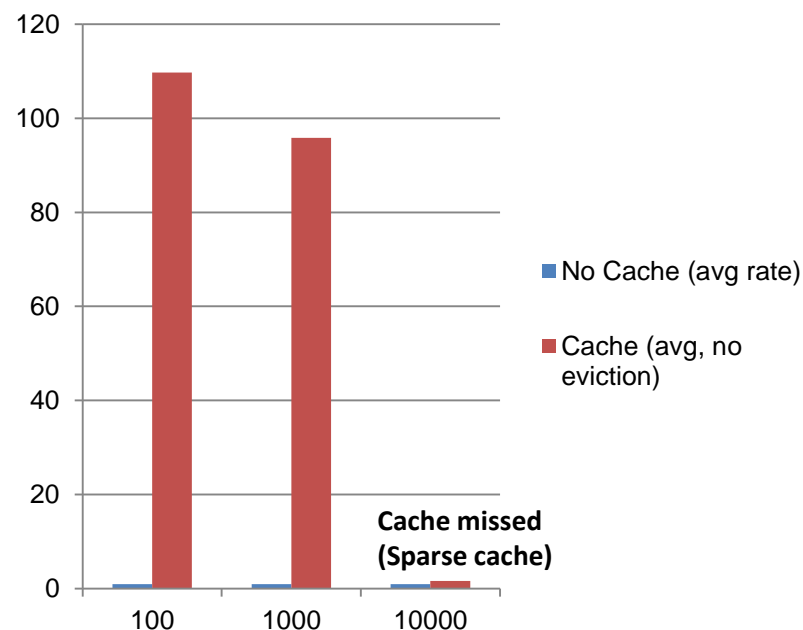

Decreasing performance along the horizontal access indicates a sparse cache (i.e. emptier cache)

Caching技术极大提高Application 运行速度、吞吐量、最终用户使用体验。

Redis是当前业界最流行的缓存技术

开源的缓存数据库排名-From DB engine

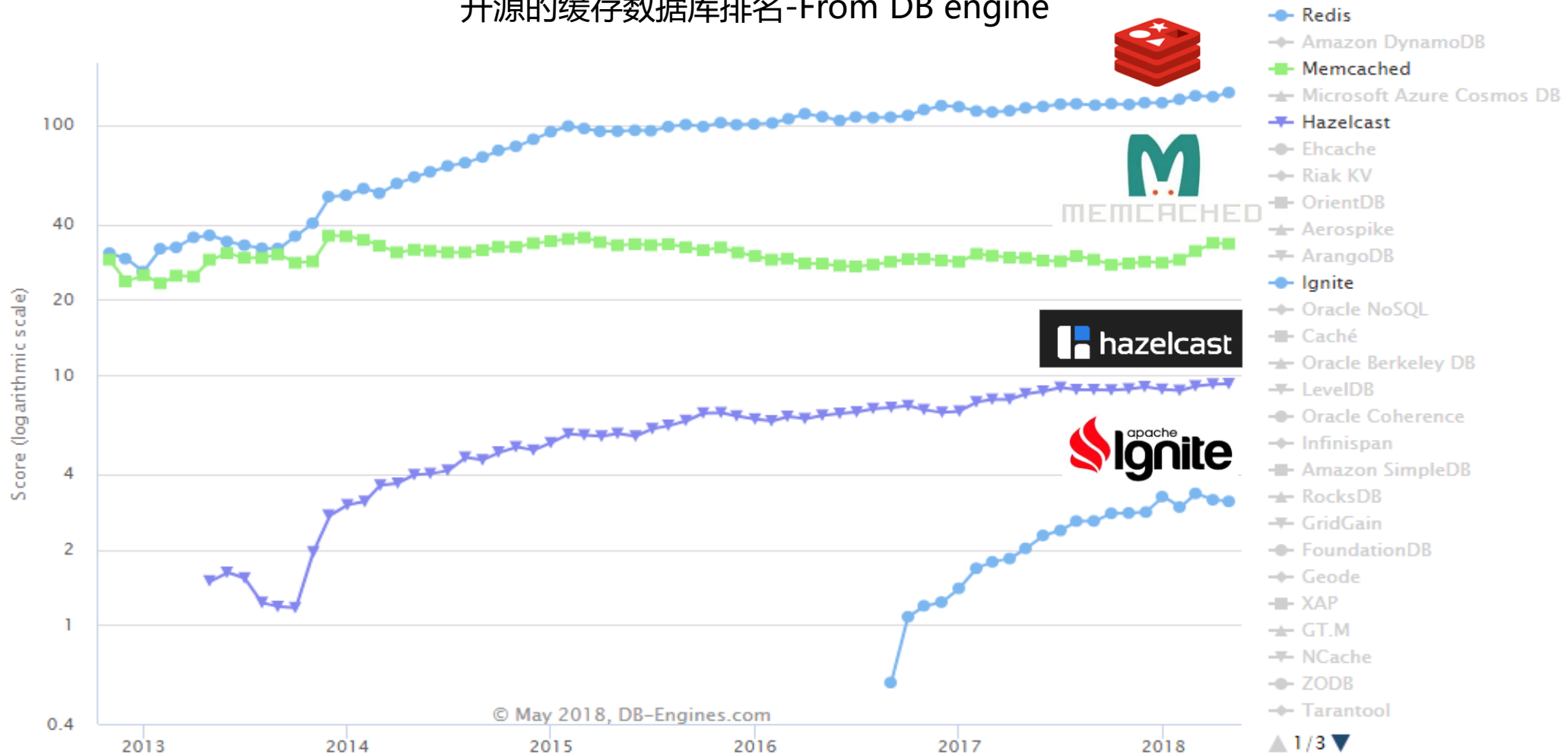

各类应用对缓存的诉求



当前云缓存存在的一些局限

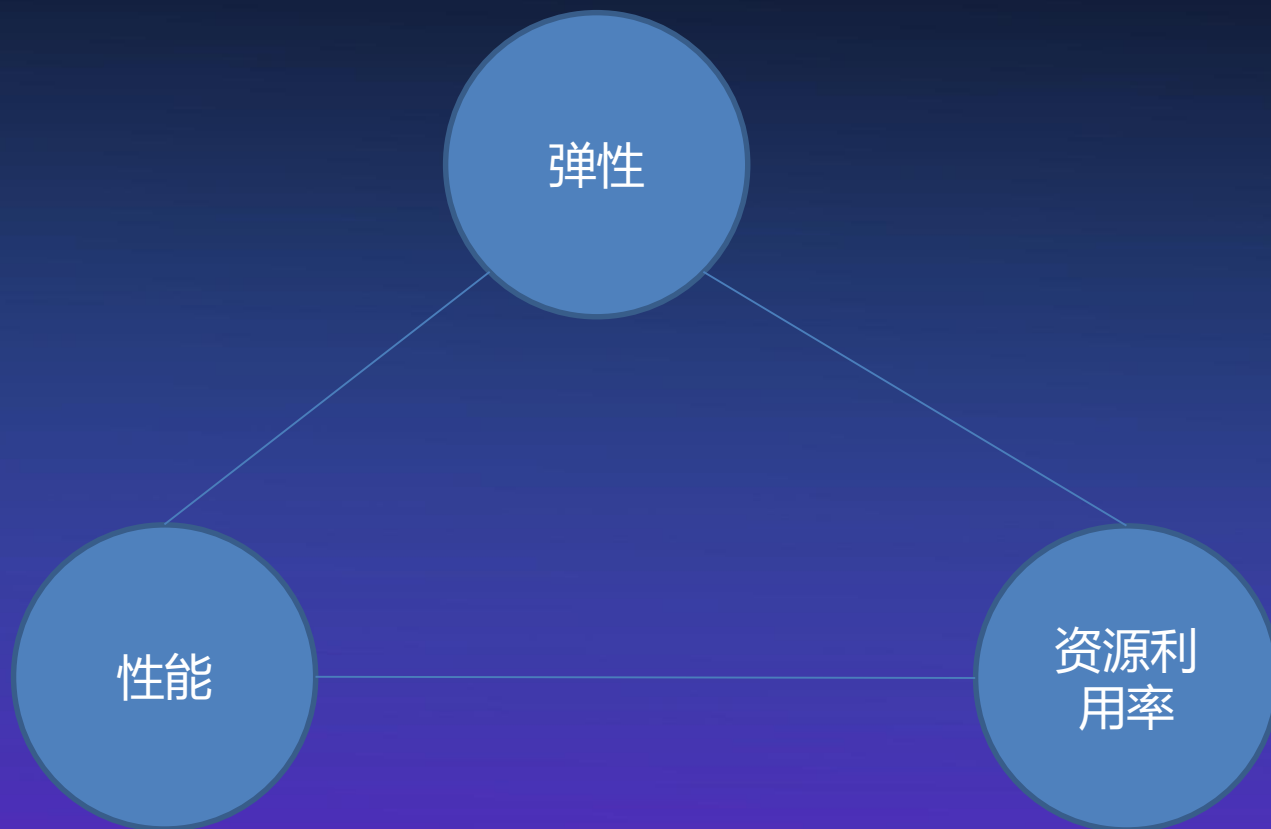

DCS2.0-灵活弹性

Replica Shard

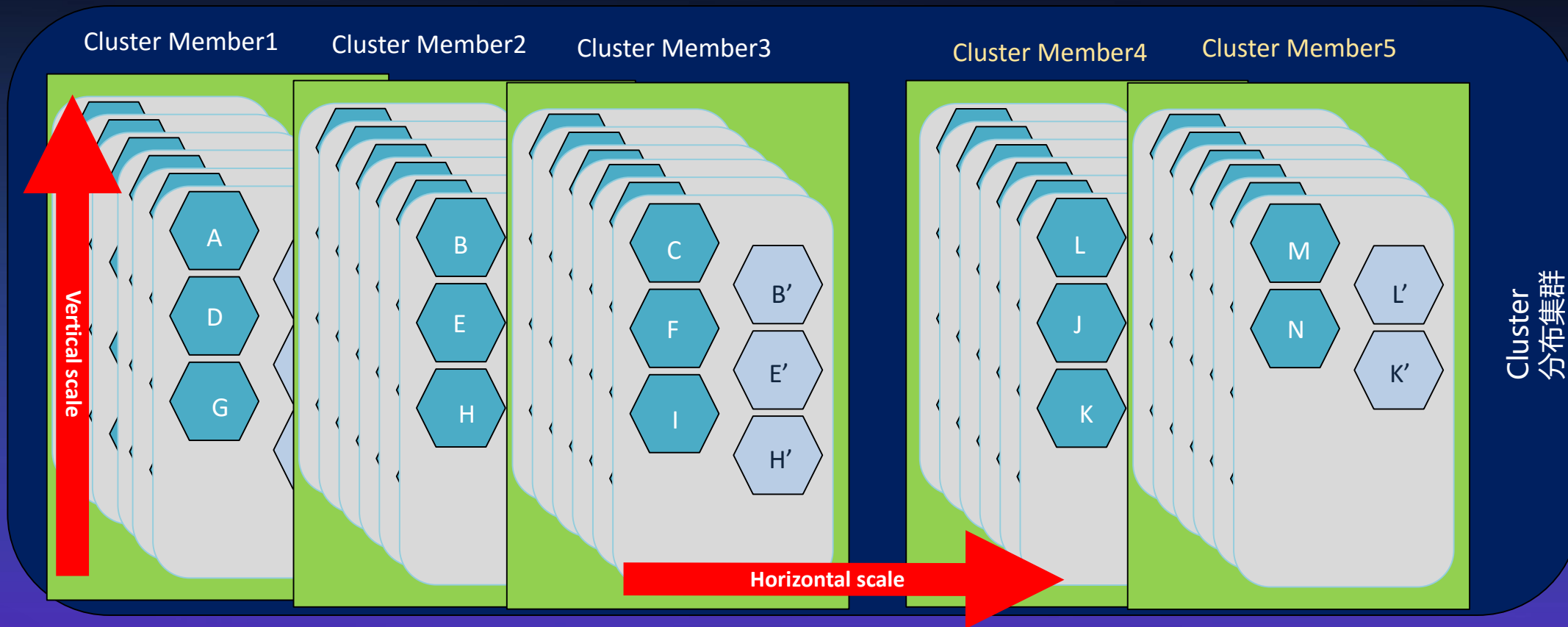
Cluster
分布集群

- 垂直伸缩：每个缓存节点的存储容量可以平滑伸缩
- 水平伸缩：基于原生Cluster集群的sharding 功能做到真正的水平伸缩

DCS2.0-极致性能

✓ 物理机部署+容器化消除虚拟层开销

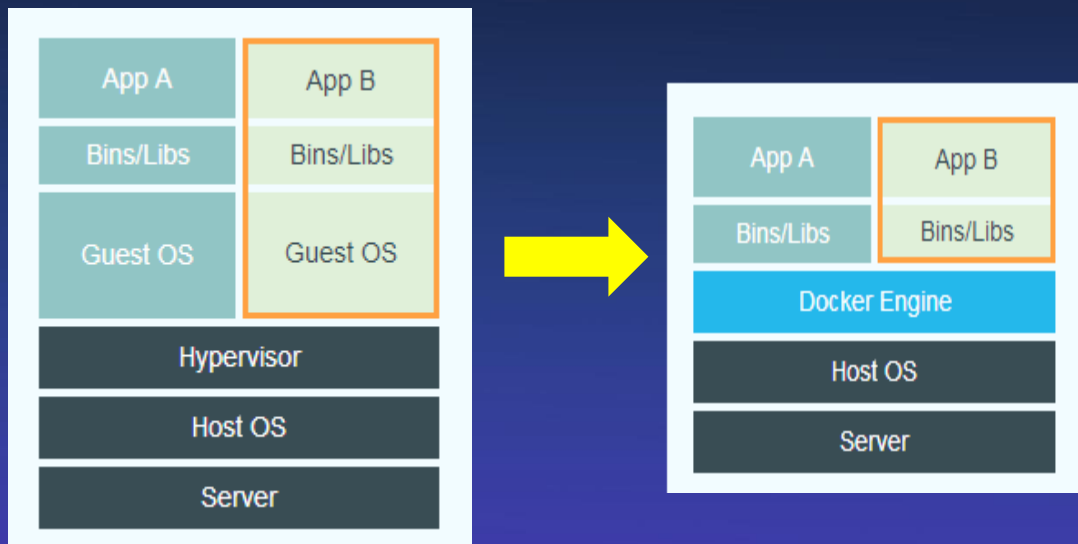

Virtual Machine

Docker

✓ 打破Proxy的性能瓶颈

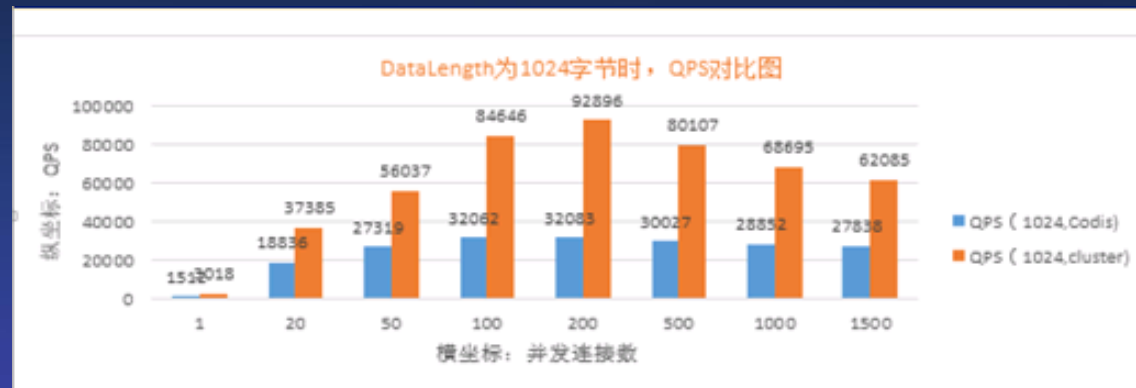

DCS2.0-资源利用率

通过容器隔离，将OS开销、主备复制开销等消耗均摊，每个单实例的内存利用率100%

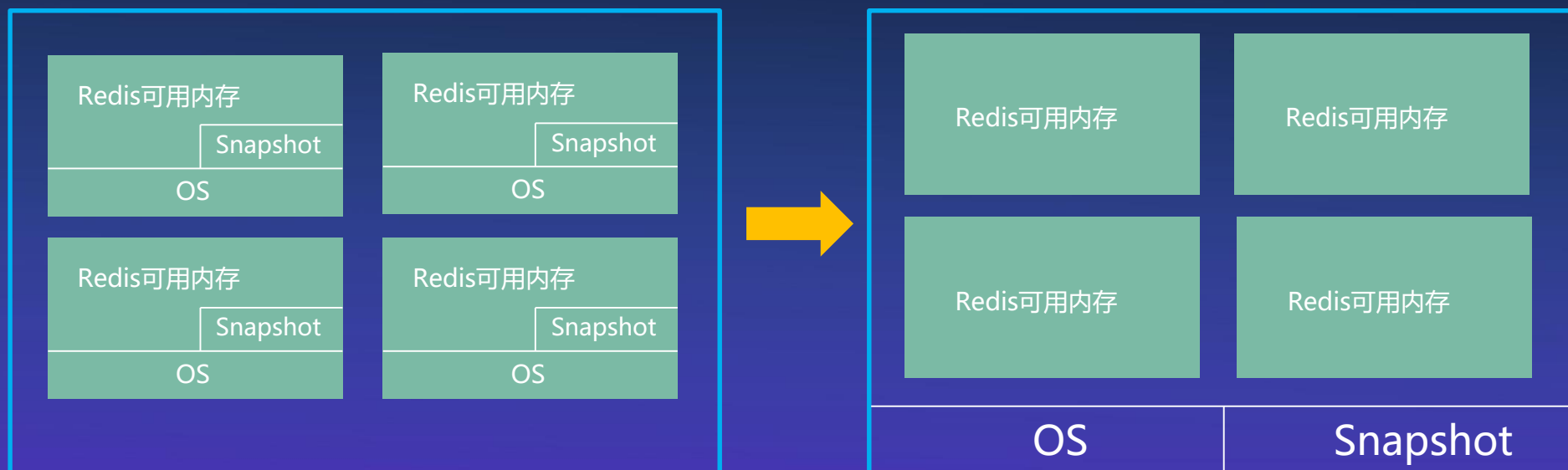

DCS2.0-资源利用率（续）

大数据场景下通过将冷数据offload到Flash，提供更高的性价比选择

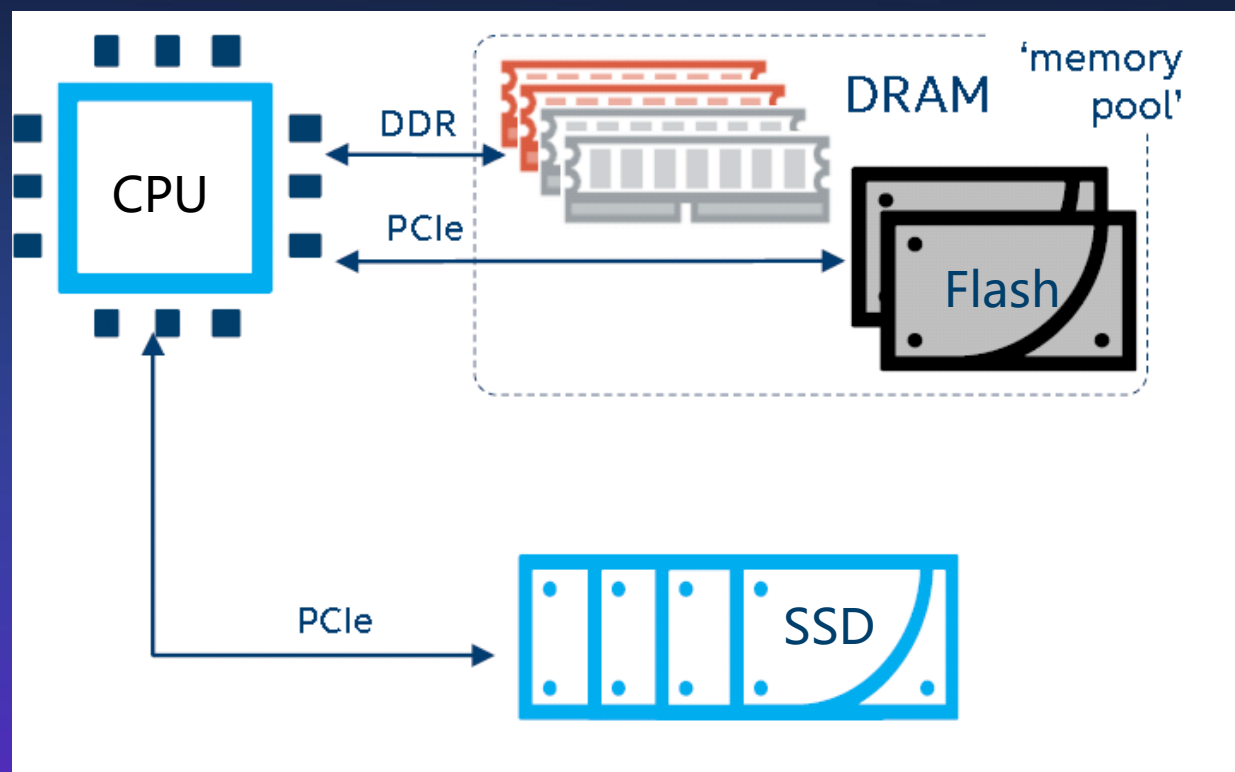

Summary

自建Redis

普通云缓存Redis

DCS2.0 Redis

Time to Run

0.5~1人天

5~10分钟

秒级启动



扩展性

2^N为规格
手动操作

2^N为规格
一键触发

1G->2G->3G...64G
一键触发

资源利用率

~70%

~70%

~100%



性能

受限于虚拟机性能

受限于虚拟机性能
集群受限于Proxy性能

可通过水平扩展线性
提升



华为云缓存服务DCS2.0即将上线，敬请期待！

<https://www.huaweicloud.com/product/dcs.html>



THANK YOU